

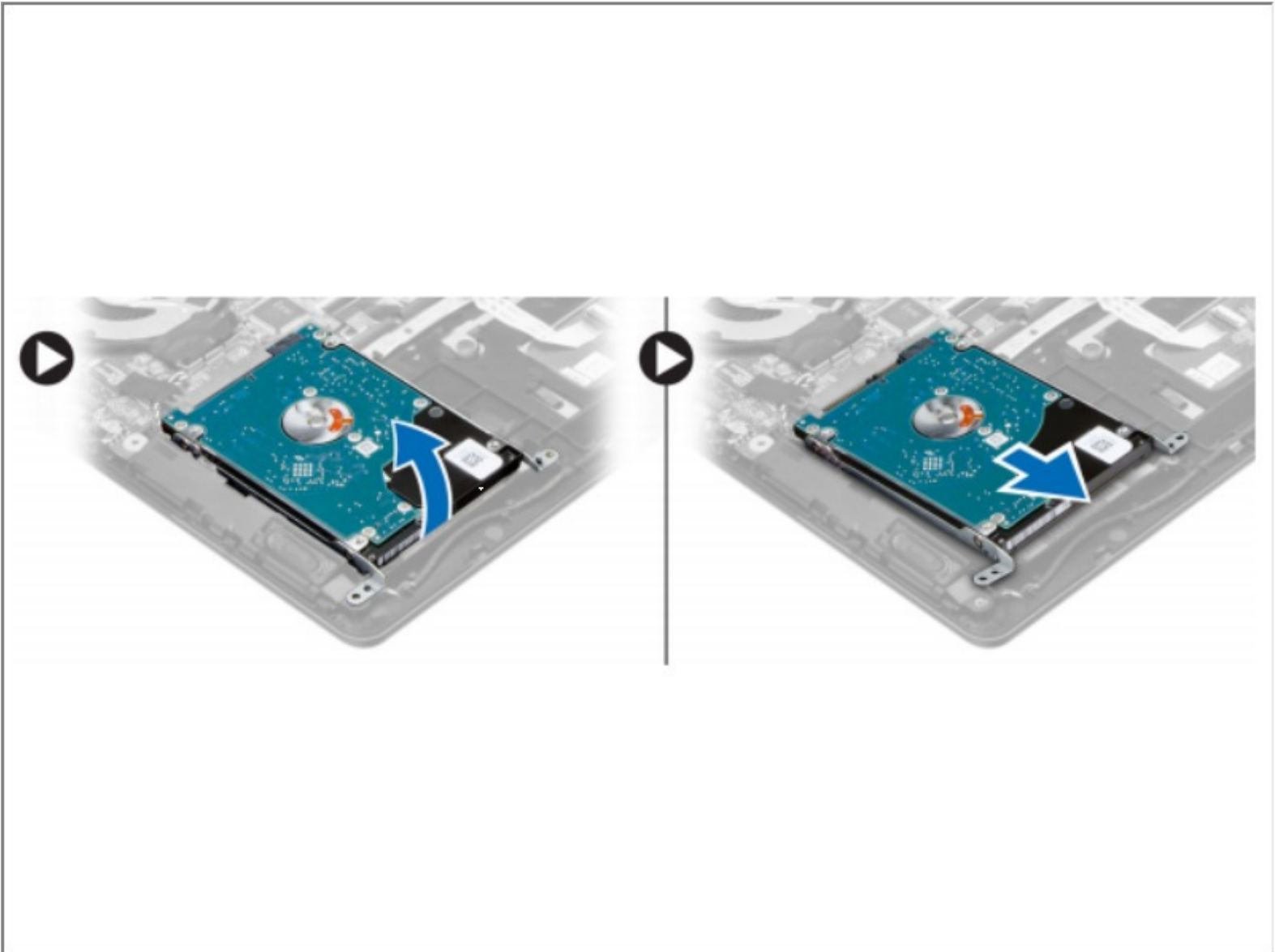

Dell Vostro 5470 Hard Drive Replacement

Written By: Johnathan Hammond



 **TOOLS:**

- [Phillips #0 Screwdriver](#) (1)
-

Step 1 — Remove the Screws

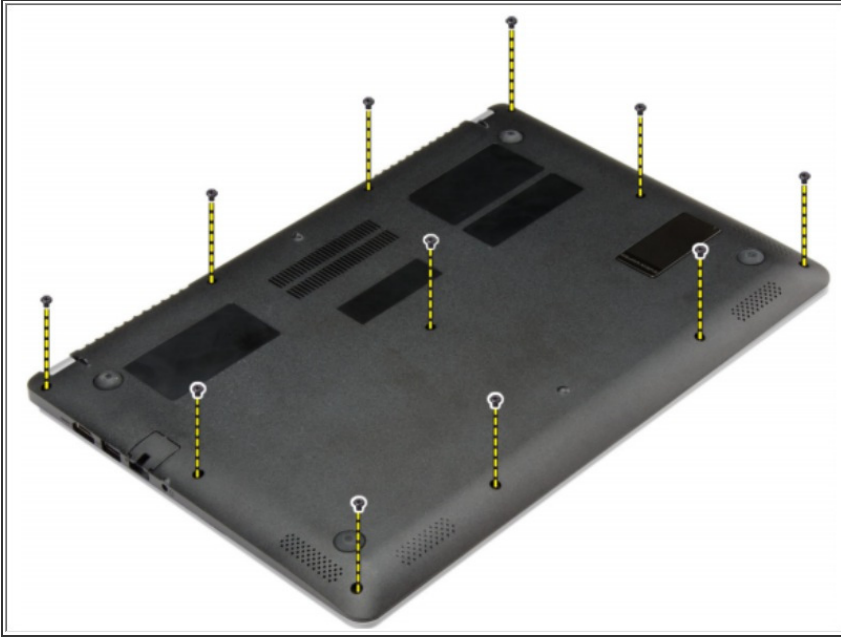

- Remove the screws that secure the base cover to the computer.

Step 2 — Loosening the Base Cover

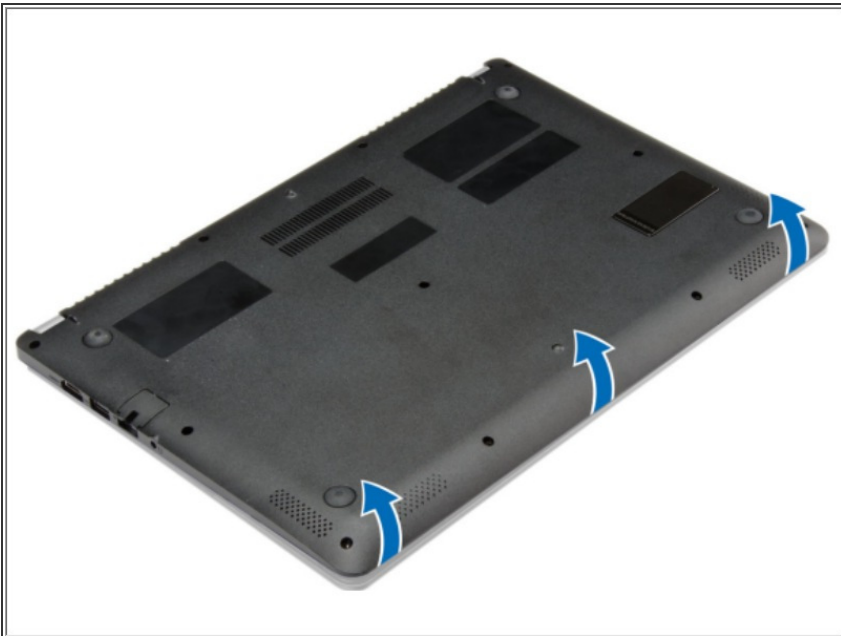

- Pry the base cover along the edges to loosen it.

Step 3 — Removing the Base Cover



- Lift and remove the base cover from the computer.
- ☑ If this is all you are doing Follow Step In Reverse if not Go to Next Step.

Step 4 — Disconnecting the Battery Cable

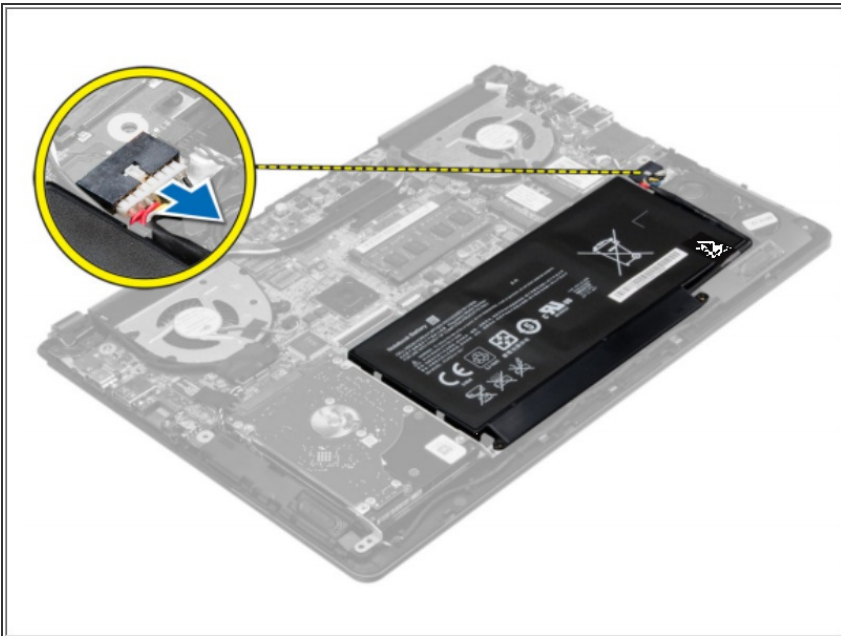

- Disconnect the battery cable from its connector on the system board.

Step 5 — Releasing the Tabs

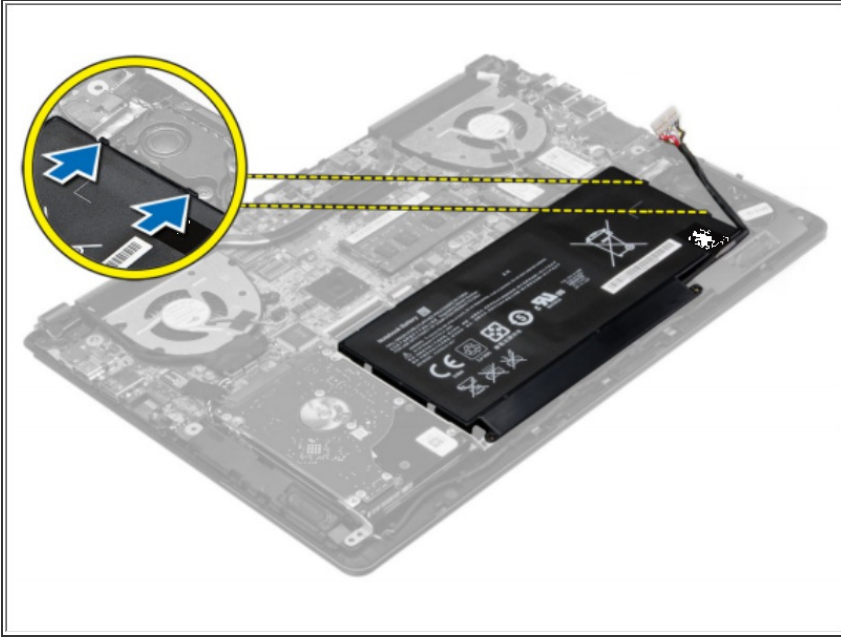

- Release the tabs that secure the battery in the battery bay.

Step 6 — Removing the Battery

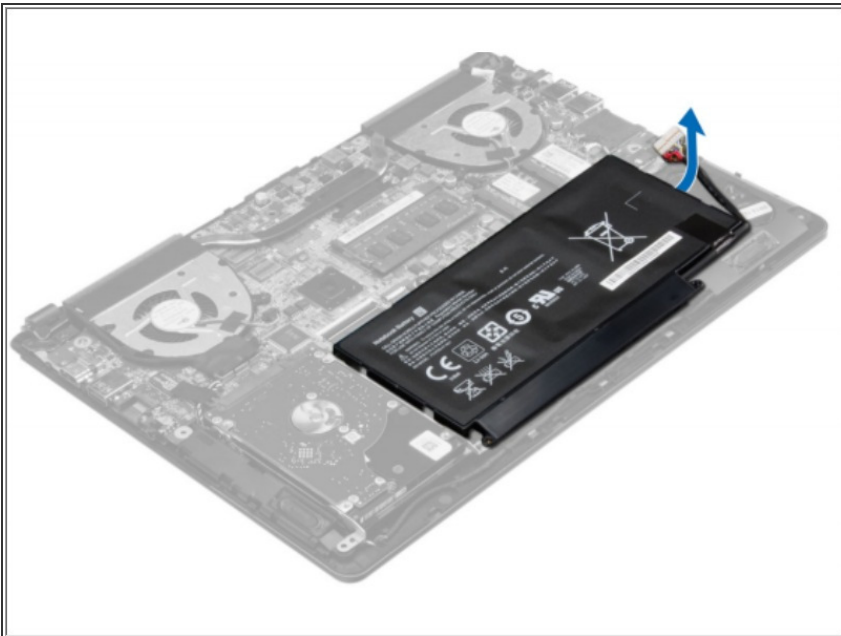

- Lift and remove the battery from the computer.
- ☑ If this is all you are doing Follow Step In Reverse if not Go to Next Step.

Step 7 — Hard Drive

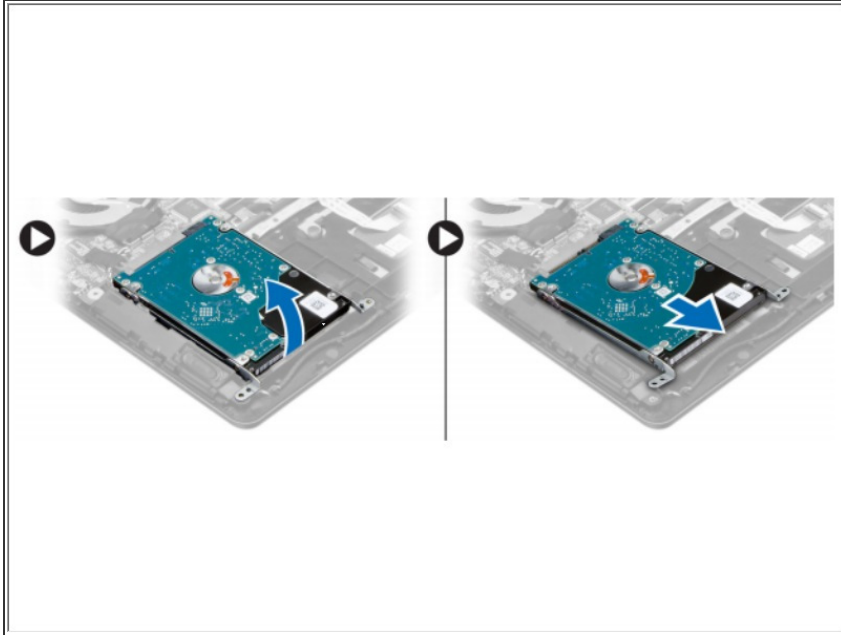

- Lift the hard drive assembly in an upward direction to release it from its compartment on the computer. Remove the hard drive from the computer.

Step 8

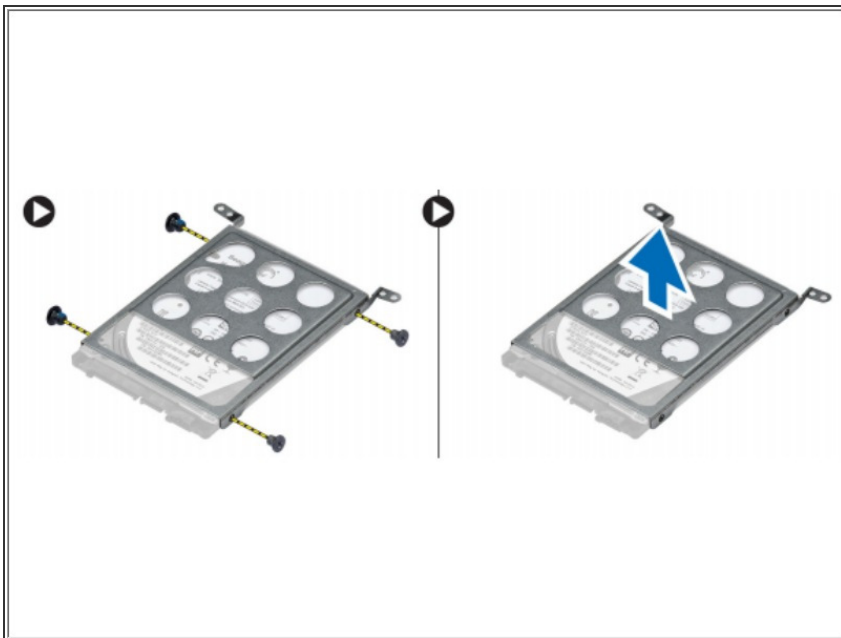

- Remove the screws that secure the hard drive to the hard drive assembly.
 - Lift and remove the hard drive from the hard drive assembly.
- If this is all you are doing Follow Step In Reverse if not Go to Next Step.

To reassemble your device, follow these instructions in reverse order.