

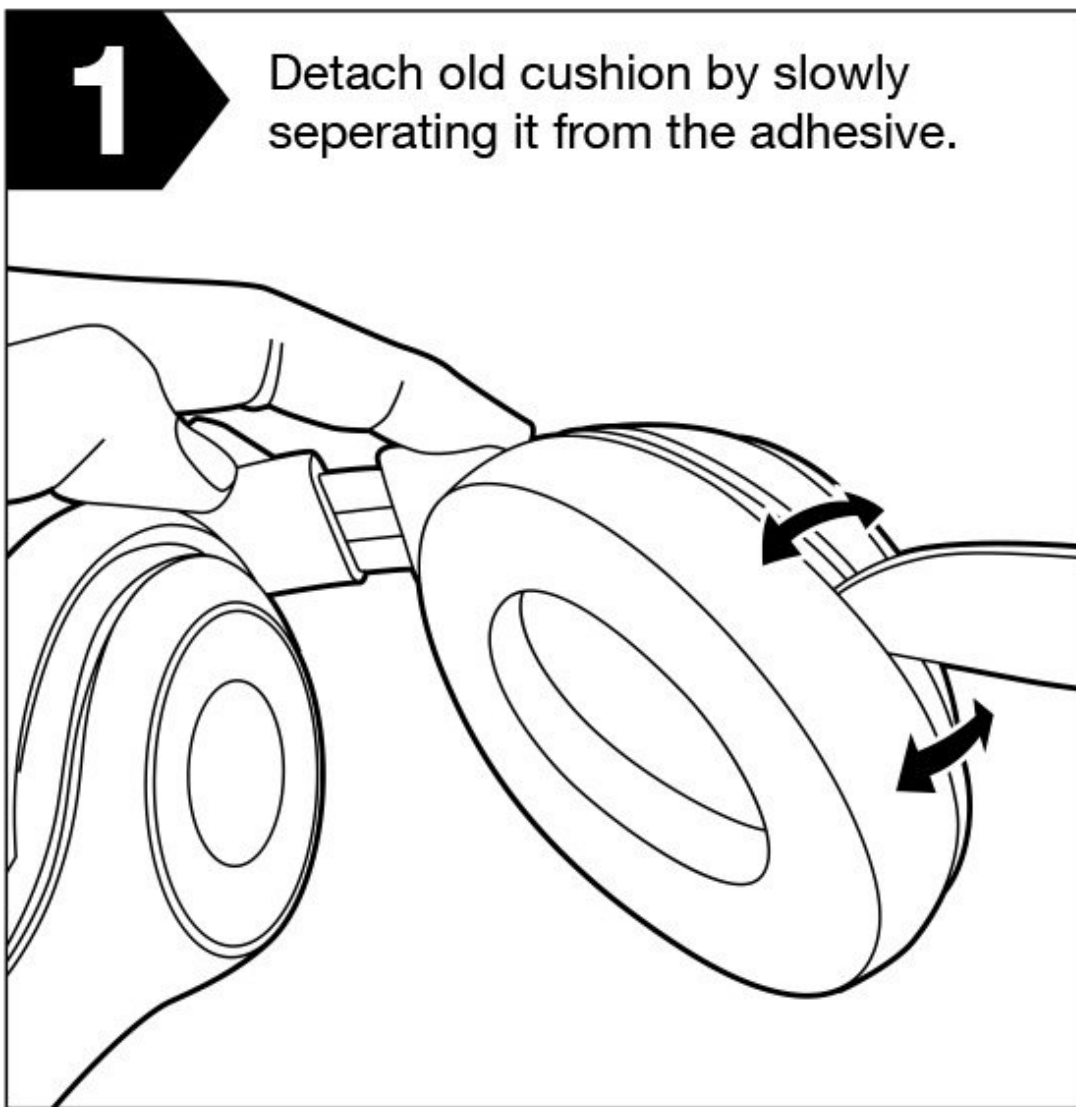

Beats Studio 2.0 Ear Pads Replacement

How to replace your beats studio 2.0 Wired/Wireless ear pads .

Written By: Wicked Cushions



INTRODUCTION

How to replace your Beats by dre studio 2.0 Wired / Wireless ear pads by Wicked Cushions



TOOLS:

- [Butter Knife](#) (1)



PARTS:

- [New pair of Earpads from Wicked Cushions](#) (1)

Step 1 — Detach the old cushion

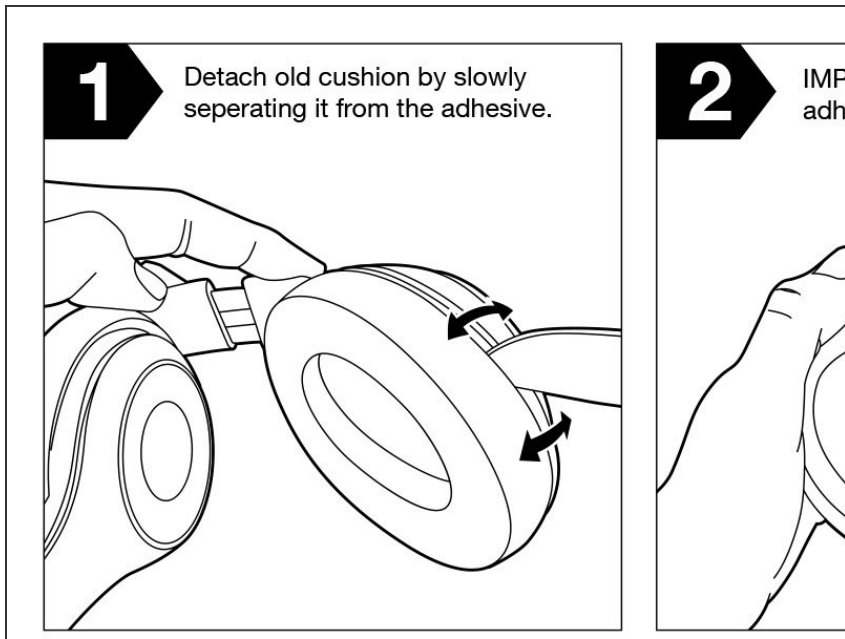

- Grab a butter knife and start separating the cushion from the headphones. We must warn you not to use anything sharper than a butter knife, it can damage your headphones as well as have the potential for injury.

Step 2 — Clean the remaining adhesive

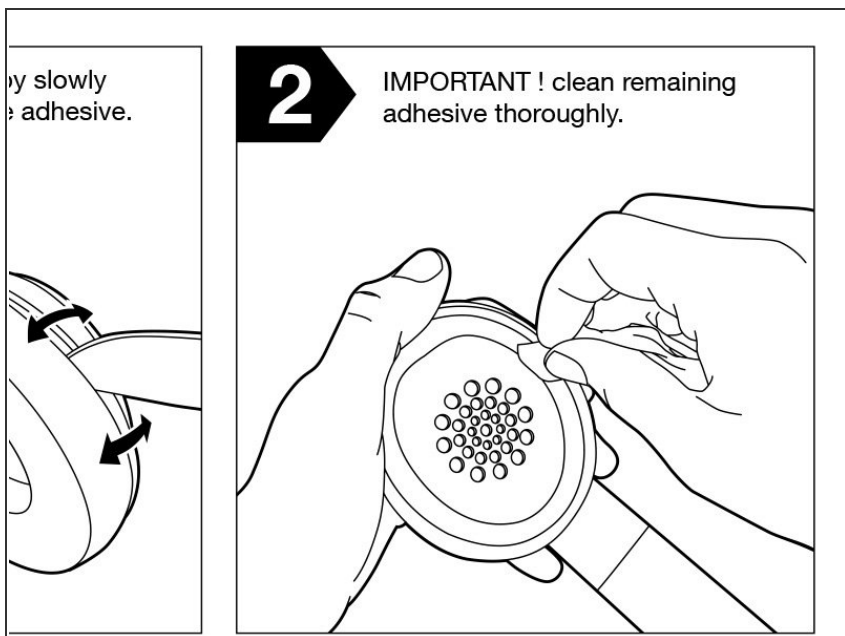

- It is very important that you clean the remaining adhesive! If you have any remaining adhesive, there will be a weird gap in-between the headphones and the cushions. You can even use an alcohol wipe to remove the adhesive. The bottom line is, the cleaner the surface, the better the ear pads will stick!

Step 3 — Grab your replacement right side cushion

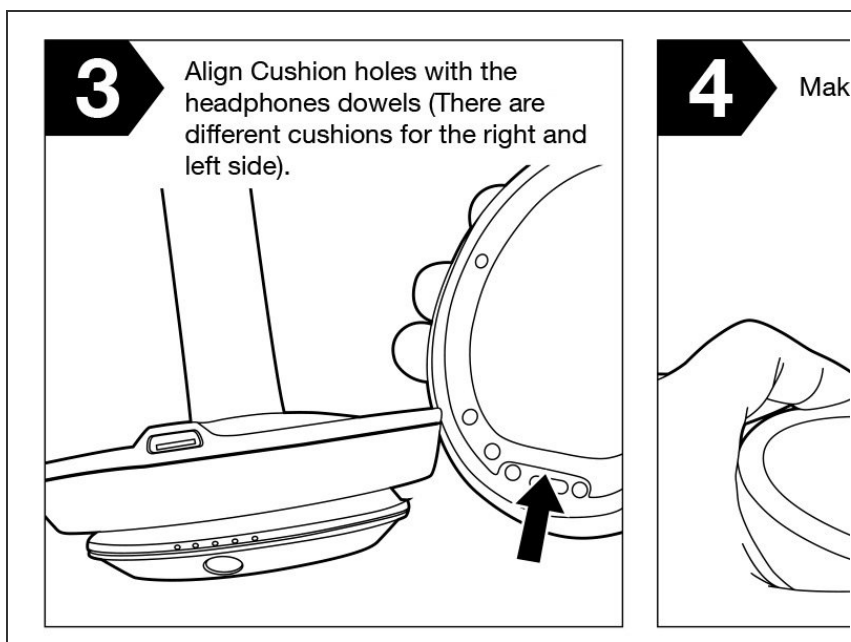

- You will see that the right side cushion is the cushion with a gap where the USB port should be. These are not an ordinary cushions, they have an extremely strong and thick adhesive that is crucial for this process to work.

Step 4 — Prepare the adhesive

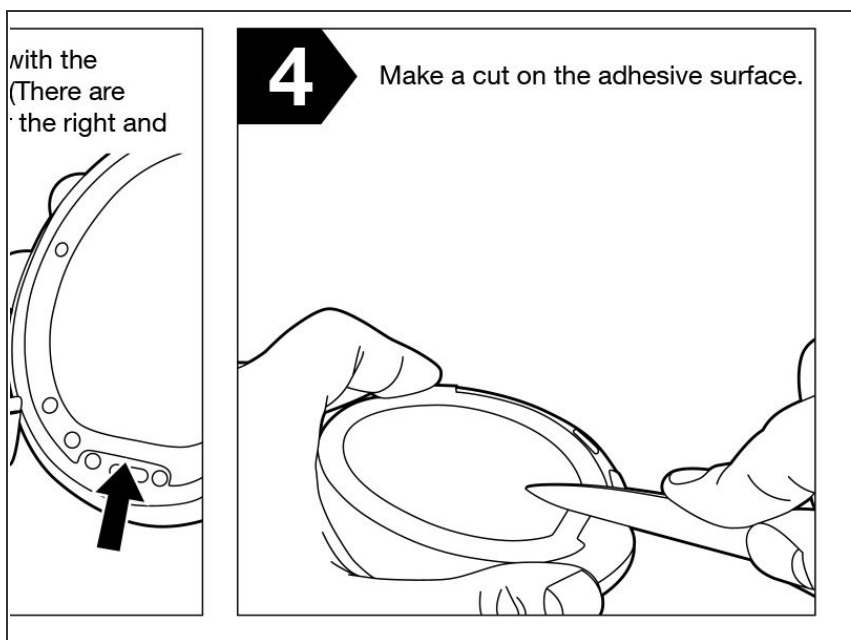

- To make it easier for you to peel the adhesive, take a sharp knife and make a small cut on the surface.

BEFORE you peel the adhesive, read the next step!

Step 5 — Align the holes with dowels on the headphones

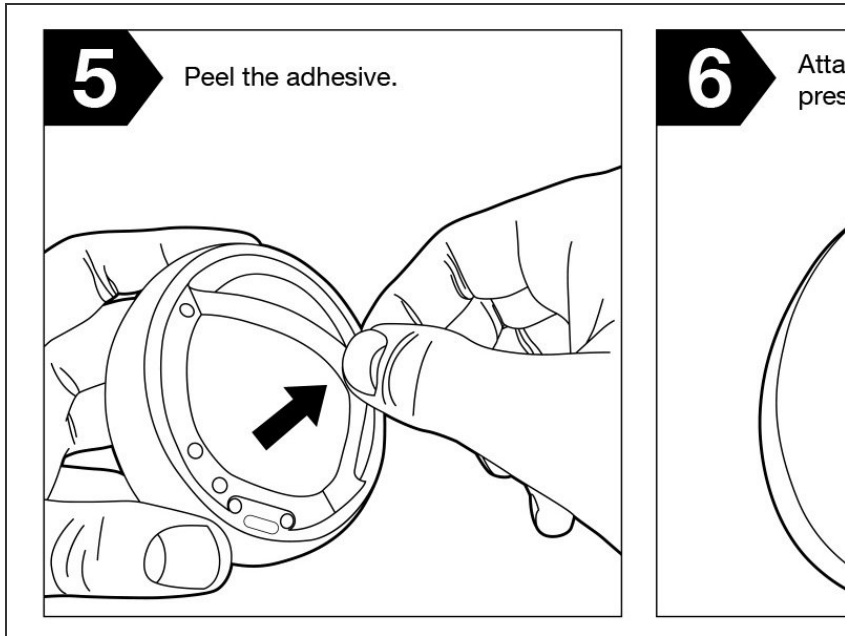

- There are two dowels on the headphone, on the top left and the bottom right. You can get a better understanding of how to apply the cushion to the headphones before peeling the adhesive.

Step 6 — Peel the adhesive & attach the ear pads

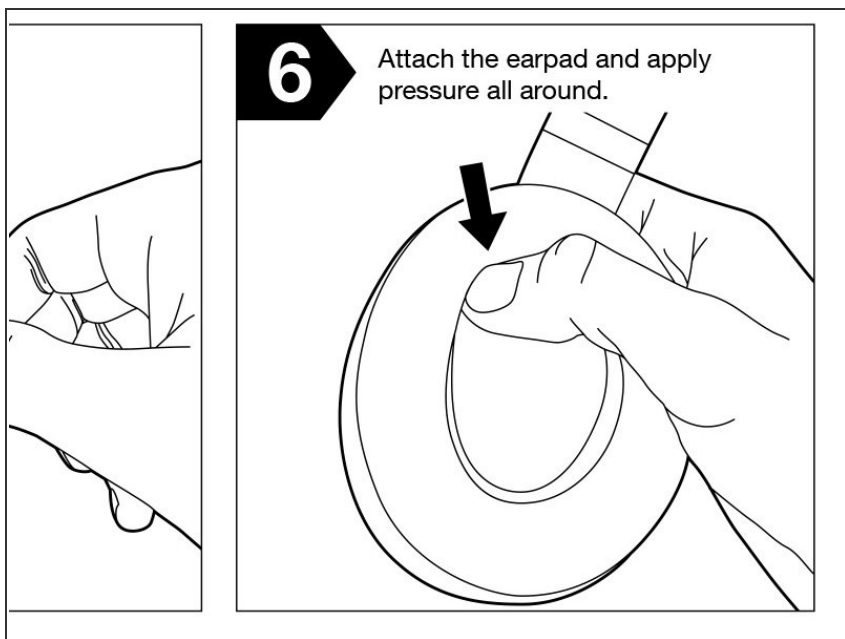

- So take your ear pad and align the top dowel to the hole, push it in, and then align the bottom one. Apply pressure on the ear pads for a good minute that way you remove any gaps. If you have noticeable gaps, that means you have not aligned the cushion correctly and try again.

Step 7 — Condition



- The last most important step! Apply constant pressure on the ear pads by taking a couple of books and putting the headphones on them in a way that applies the most pressure without bending the headphone headband to far. We hope you enjoyed this simple tutorial, if you have any questions, do not hesitate to contact us.

Step 8

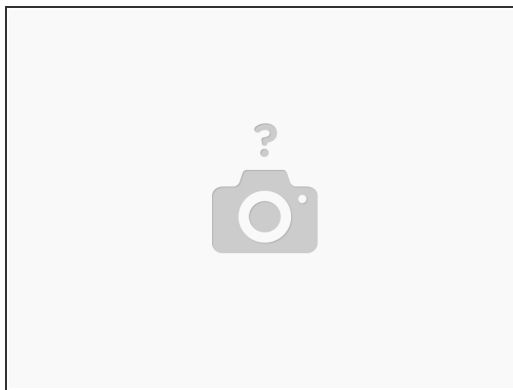

- Watch video here :
- [Click here](#)

To replace your cushions , please follow the next steps .